



## V2000BB

### BB type TRV Body

Radiator valve with broadband cartridge

#### APPLICATION

Thermostatic radiator valve bodies (TRV bodies) are fitted on the supply or return of radiators or heat exchangers.

Together with a radiator thermostat, for example the Thera-4, they control the room temperature by regulating the flow of hot water into the radiator or heat exchanger. The temperature of different rooms is controlled individually and energy is saved.

TRV bodies of this type have quiet operation and are fitted to the supply of radiators on two-pipe systems with medium flow rates.

The valve insert can be replaced while the system is running and without draining using the service tool (see 'Accessories').

- Honeywell Home radiator thermostats with M30 x 1.5 connection
- Certain Honeywell Home MT4 actuators
- Honeywell Home Hometronic HR80 and Roomtronic HR40 actuators

#### AT-CONCEPT

AT-Concept valves share the same valve housing design. The valve insert can be replaced by any other AT-Concept valve insert, i.e. BB, KV, UBG, SL, VS, FS, FV and SC.

#### FEATURES

- For heating systems with medium flow rates
- Available for installation on the supply or on the return
- Quiet operation
- DIN type bodies with dimensions according to EN 215, Appendix A, Series D
- NF type bodies with dimensions according to EN 215, Appendix A, Series F
- AT-Concept valve housing and insert
- Valve insert can be replaced while system is operating and without draining the system
- Valve opening spring is not in the water
- Standard M30 x 1.5 thermostat connection
- Supplied with black protection cap, imprinted 'BB' for clear identification

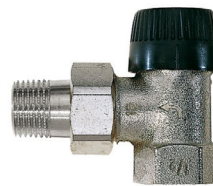

V2000EB



V2000DB



V2020EB



V2020DB



V2000AB



V2000LB



V2000RB



V2000BB



V2000HB



V2000IB



## DESIGN

The thermostatic radiator valve body consists of:

- Valve housing PN10, DN10, 15 or 20 with
  - internal thread connection to DIN2999 (ISO7) for threaded, copper or precision steel pipe on inlet (compression ring fittings see 'Accessories')
  - external thread connection with union-nut and radiator tailpiece on outlet (Eurocone for DN15)
  - angle to DIN and straight to DIN bodies with dimensions according to EN215, Appendix A, Series D
  - angle to NF and straight to NF bodies with dimensions according to EN215, Appendix A, Series F
- Valve insert with BB (broadband) type cartridge
- Protection cap
- Union-nut and radiator tailpiece

## MATERIALS

- Valve housing made of nickel-plated hot-forged brass
- Valve insert made of brass with EPDM O-rings and soft seals and stainless steel spindle
- Protection cap made of black plastic
- Union-nut and tailpiece made of nickel-plated brass

## PLEASE NOTE:

- To avoid stone deposit and corrosion the composition of the medium should conform with VDI-Guideline 2035
- Additives have to be suitable for EPDM sealings
- System has to be flushed thoroughly before initial operation with all valves fully open
- Any complaints or costs resulting from non-compliance with above rules will not be accepted by Honeywell Home
- Please contact us if you should have any special requirements or needs

## INSTALLATION EXAMPLES

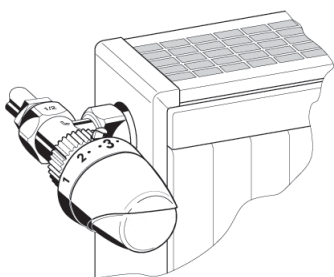

Fig. 1. Angle

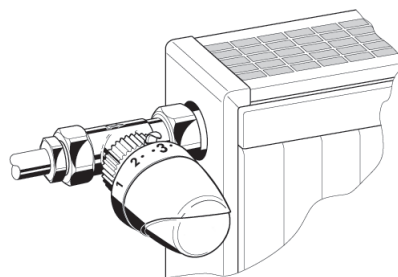

Fig. 2. Straight

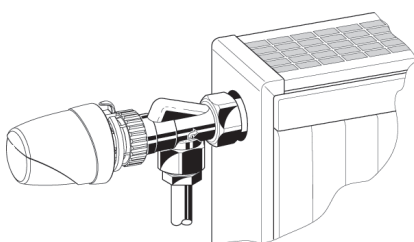

Fig. 3. Horizontal angle

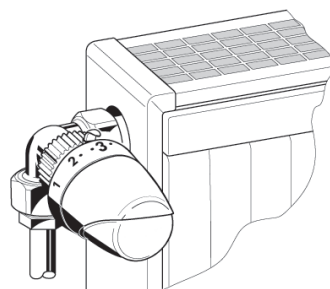

Fig. 4. Corner angle

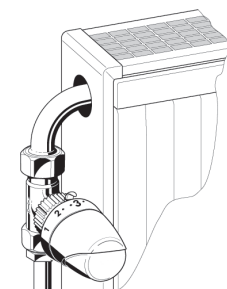

Fig. 5. Straight with swanneck

## SPECIFICATIONS

Medium:	Heating water, water quality to VDI2035
Operating temperature:	max. 130 °C (266°F)
Operating pressure:	PN10
Differential pressure:	max. 100kPa (1 bar, 14.5 psi) – max. 20 kPa (0.2 bar, 2.9 psi) recommended for quiet operation
$k_{vs}$ ( $C_{vs}$ )-value:	0.62 (0.73)
Nominal flow:	120 kg/h
Body-head connection:	M30 x 1.5
Closing dimension:	11.5 mm
Stroke:	2.5 mm
Spec. stroke:	0.22 mm/K

## IDENTIFICATION

- Black protection cap, 'BB' embossed on top of cap
- 'B' imprinted 3x on top of valve insert

## FUNCTION

Thermostatic radiator valves enable individual control of room temperature and thus save energy.

The TRV body is controlled by the radiator thermostat. Air from the room passing over the sensor of the radiator thermostat causes the sensor to expand when the temperature rises. The sensor acts onto the valve spindle and this causes the TRV body to close. When the temperature falls the sensor contracts and the spring-loaded valve spindle is opened. The TRV opens in proportion to the temperature of the sensor. Only the amount of water required to maintain the room temperature set on the radiator thermostat can flow into the radiator.

## DIMENSIONS AND ORDERING INFORMATION

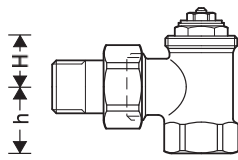

**Fig. 6. Angle**

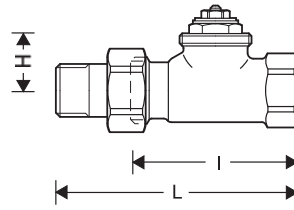

**Fig. 7. Straight**

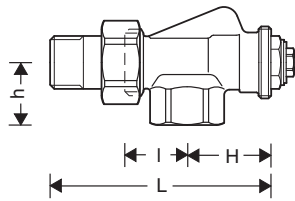

**Fig. 8. Horizontal angle**

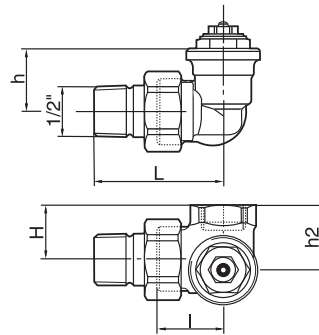

**Fig. 9. Corner angle**

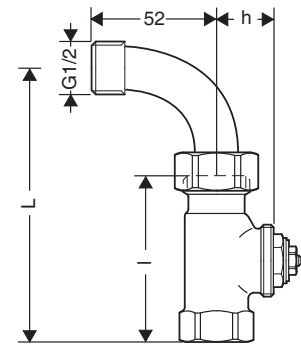

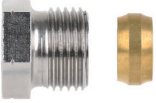
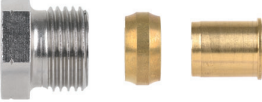



**Fig. 10. Straight with swanneck**



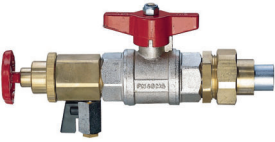

Table 1. Dimensions and Item No.

Body type	DN	EN215 certified	$k_{vs}(C_{vs})$ -value	Pipe connection	I	L	h	H	h <sub>2</sub>	Item No.
<b>For the supply</b>										
Angle to EN215 (D) (Fig. 6)	10	•	0.62 (0.73)	Rp 3/8"	26	52	22	20	-	V2000EBB10
	15	•	0.62 (0.73)	Rp 1/2"	29	58	26	20	-	V2000EBB15
	20	•	0.62 (0.73)	Rp 3/4"	34	66	29	19	-	V2000EBB20
Straight to EN215 (D) (Fig. 7)	10	•	0.62 (0.73)	Rp 3/8"	59	85	-	25	-	V2000DBB10
	15	•	0.62 (0.73)	Rp 1/2"	66	95	-	25	-	V2000DBB15
	20	•	0.62 (0.73)	Rp 3/4"	74	106	-	25	-	V2000DBB20
Angle to EN215 (F) (Fig. 6)	10	•	0.62 (0.73)	Rp 3/8"	24	49	20	21	-	V2020EBB10
	15	•	0.62 (0.73)	Rp 1/2"	26	53	23	22	-	V2020EBB15
	20		0.62 (0.73)	Rp 3/4"	34	66	29	18	-	V2020EBB20
Straight to EN215 (F) (Fig. 7)	10	•	0.62 (0.73)	Rp 3/8"	50	75	-	26	-	V2020DBB10
	15	•	0.62 (0.73)	Rp 1/2"	55	82	-	26	-	V2020DBB15
	20		0.62 (0.73)	Rp 3/4"	74	106	-	24	-	V2020DBB20
Horizontal angle (Fig. 8)	10		0.62 (0.73)	Rp 3/8"	24	50	22	33	-	V2000ABB10
	15		0.62 (0.73)	Rp 1/2"	26	54	26	35	-	V2000ABB15
Corner angle, radiator connection left (Fig. 9)	10		0.62 (0.73)	Rp 3/8"	24	53	26	22	26.5	V2000LBB10
	15		0.62 (0.73)	Rp 1/2"	24	53	26	26	30.5	V2000LBB15
Corner angle, radiator connection right (Fig. 9)	10		0.62 (0.73)	Rp 3/8"	24	53	26	22	26.5	V2000RBB10
	15		0.62 (0.73)	Rp 1/2"	24	53	26	26	30.5	V2000RBB15
Swanneck (Fig. 10)	15		0.62 (0.73)	Rp 1/2"	66	108	25	-	-	V2000BBB15
<b>For the return</b>										
Horizontal angle (Fig. 8)	15		0.62 (0.73)	Rp 1/2"	29	58	26	23	-	V2000HBB15
Straight (Fig. 7)	15		0.62 (0.73)	Rp 1/2"	65	95	-	23	-	V2000IBB15

Note: All dimensions in mm unless stated otherwise.

## ACCESSORIES

	Description	Dimension	Item No.
	<b>FIG3/8CS</b> <b>Compression fitting for COPPER and STEEL pipe</b> Consisting of compression nut and compression ring. For valves with internal thread. Note: Support inserts have to be used for copper or soft steel pipe with 1.0 mm wall thickness. Max. operating temperature 120 °C, max. operating pressure 10 bar.		
	$\frac{3}{8}$ " DN10	10 mm	FIG3/8CS10
	$\frac{3}{8}$ " DN10	12 mm	FIG3/8CS12
	$\frac{1}{2}$ " DN15	10 mm	FIG1/2CS10
	$\frac{1}{2}$ " DN15	12 mm	FIG1/2CS12
	$\frac{1}{2}$ " DN15	14 mm	FIG1/2CS14
	$\frac{1}{2}$ " DN15	15 mm	FIG1/2CS15
	$\frac{1}{2}$ " DN15	15 mm	FIG1/2CS15-10
	$\frac{1}{2}$ " DN15	16 mm	FIG1/2CS16
	$\frac{3}{4}$ " DN18	18 mm	FIG3/4CS18
	$\frac{3}{4}$ " DN22	22 mm	FIG3/4CS22
	<b>FIG3/8CSS</b> <b>Compression fitting for COPPER and STEEL pipe</b> Consisting of compression nut and compression ring and support insert. For valves with internal thread. Note: Support inserts have to be used for copper or soft steel pipe with 1.0 mm wall thickness. Max. operating temperature 120 °C, max. operating pressure 10 bar.		
	$\frac{3}{8}$ " DN10	12 mm	FIG3/8CSS12
	$\frac{1}{2}$ " DN15	12 mm	FIG1/2CSS12
	$\frac{1}{2}$ " DN15	14 mm	FIG1/2CSS14
	$\frac{1}{2}$ " DN15	15 mm	FIG1/2CSS15
	$\frac{1}{2}$ " DN15	16 mm	FIG1/2CSS16
	$\frac{1}{2}$ " DN15	18 mm	FIG1/2CSS18
	$\frac{3}{4}$ " DN20	18 mm	FIG3/4CSS18
		<b>FIG1/2M</b> <b>Compression fitting for MULTILAYER pipe. Consisting of compression nut, compression ring and support insert. For valves with internal thread.</b> Note: Max. operating temperature 90°C, max. operating pressure 10 bar	
$\frac{1}{2}$ " DN15		16 mm	FIG1/2M16X2
	<b>VA6290</b> <b>Reduction piece</b>		
	1" pipe > $\frac{1}{2}$ " valve		VA6290A260
	1 $\frac{1}{4}$ " pipe > $\frac{1}{2}$ " valve		VA6290A280
	1" pipe > $\frac{3}{4}$ " valve		VA6290A285
	1 $\frac{1}{4}$ " pipe > $\frac{3}{4}$ " valve		VA6290A305
	<b>VA5201Axxx</b> <b>Radiator tailpiece with thread up to collar</b>		
	for valves DN10 ( $\frac{3}{8}$ "		VA5201A010
	for valves DN15 ( $\frac{1}{2}$ "		VA5201A015
	for valves DN20 ( $\frac{3}{4}$ "		VA5201A020
	<b>VA5204Bxxx</b> <b>Extended radiator tailpiece, nickel-plated, to be shortened as required</b>		
	$\frac{3}{8}$ " x 70 mm (for DN10) thread approx. 50 mm		VA5204B010
	$\frac{1}{2}$ " x 76 mm (for DN15) thread approx. 65 mm		VA5204B015
	$\frac{3}{4}$ " x 70 mm (for DN20) thread approx. 60 mm		VA5204B020

	<b>VA2200Dxxx</b>	<b>Manual handwheel cap</b>	
		Presettable, with integrated locking device	VA2200D001
	<b>VA2202Axxx</b>	<b>Pressure cap – for shutting off valves on radiator outlet</b>	
		for valves DN10 ( $\frac{3}{8}$ "	VA2202A010
		for valves DN15 ( $\frac{1}{2}$ "	VA2202A015
		for valves DN20 ( $\frac{3}{4}$ "	VA2202A020
	<b>VA5090</b>	<b>Sealing ring for pressure cap</b>	
		for valves DN10 ( $\frac{3}{8}$ "	VA5090A010
		for valves DN15 ( $\frac{1}{2}$ "	VA5090A015
		for valves DN20 ( $\frac{3}{4}$ "	VA5090A020
	<b>VA8200A</b>	<b>Service tool to replace valve insert</b>	
			for all sizes VA8200A001
	<b>VS1200</b>	<b>Replacement valve insert</b>	
		BB type	VS1200BB01

## FLOW DIAGRAM

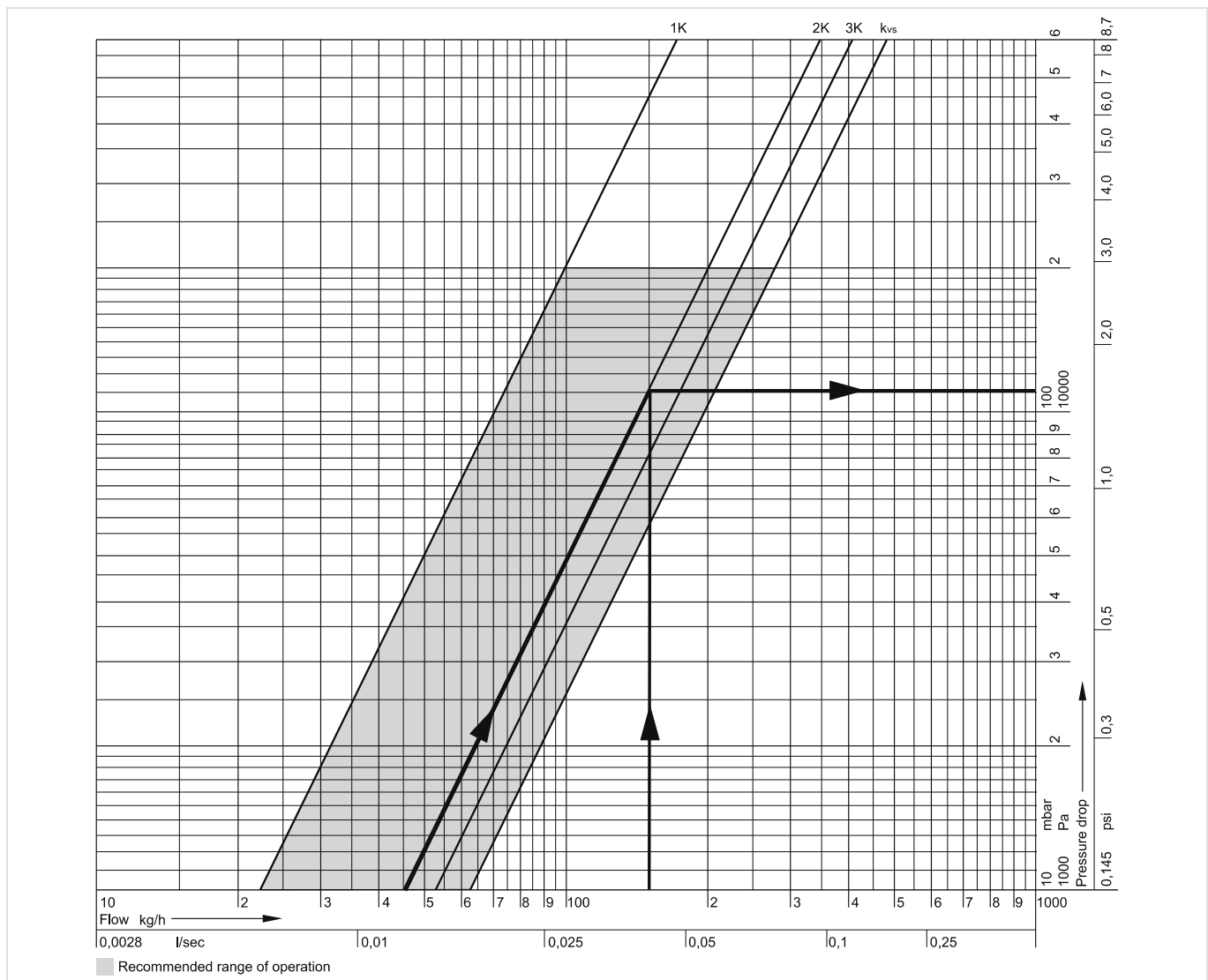

P-Band	1K	2K	3K	open = kvs
k <sub>v</sub> -value	0.22	0.45	0.52	0.62
cv-value	0.26	0.53	0.61	0.73

### Design example

Given: Flow rate 150 kg/h  
 Required: Pressure loss ( $\Delta p$ ) with a P-band of 2K  
 Solution: The required pressure loss is found at the intersection of the flow line with the line for the chosen valve performance P=2K  
 Result:  $\Delta p = 110 \text{ mbar} = 11\,000 \text{ Pa}$

### For more information

resideo.com



Ademco 1 GmbH  
 Hardhofweg 40  
 74821 MOSBACH  
 GERMANY  
 Phone: +49 6261 810  
 Fax: +49 6261 81309

Manufactured for and on behalf of the  
 Pittway Sàrl, La Pièce 6, 1180 Rolle, Switzerland  
 by its Authorised Representative Ademco 1 GmbH  
 EN0H-2100GE25 R0223

Subject to change

© 2023 Pittway Sàrl. All rights reserved.

This document contains proprietary information of Pittway Sàrl and its affiliated companies and is protected by copyright and other international laws. Reproduction or improper use without specific written authorisation of Pittway Sàrl is strictly forbidden. The Honeywell Home trademark is used under license from Honeywell International Inc.

**Honeywell Home**