



V2100PI

Kombi-TRV

Pressure Independent Thermostatic Radiator Valve

APPLICATION

Kombi-TRV is a pressure independent thermostatic radiator valve, designed to be fitted on the supply of radiators in two-pipe heating systems with medium flow rates.

The combination of a presettable thermostatic radiator valve and a differential pressure control valve in one product enable a significant increase of the two-pipe heating systems efficiency.

Standard dimensions according to EN215 make Kombi-TRV a perfect and simple solution for new buildings, renovation and retrofit projects.

APPROVALS

- EN 215
- Keymark

SPECIAL FEATURES

- Flow rate easily adjustable by standard wrench size 7 or a special setting key (see "Accessories")
- Integrated differential pressure controller
- Standard dimensions according to EN215
- Kombi-TRV valves are compatible with
 - Honeywell Home radiator thermostats with M30 x 1.5 connection
 - Honeywell Home MT4 actuators
 - Honeywell Home M5410 2-point actuators
 - Honeywell Home HR types of Home and Roomtronic actuators
 - Honeywell Home M4410E/K and M7410E5001 modulating actuators
- The valve insert can be replaced while the system is operating and without draining using the service tool (see 'Accessories')
- Valve housing and insert does not fit to Honeywell Home AT-Concept design

TECHNICAL DATA

Media	
Standard medium:	Water or water-glycol mixture, quality to VDI 2035
pH-value:	8 - 9.5
Connections/Sizes	
Body-head connection:	M30 x 1.5
Sizes:	DN10, DN15, DN20



Operating temperatures	
Max. operating temperature medium:	90 °C (194 °F)
Min. operating temperature medium:	2 °C (35.6 °F)
Pressure values	
Max. operating pressure:	PN10, 10 bar (1000kPa)
Max. differential pressure:	0.6 bar (60 kPa)
Min. differential pressure:	0.1 bar (10 kPa)
Flow rates	
Flow range:	10 - 160 l/h
Presetting accuracy:	± 15 %
Max. nominal flow at 10 kPa (EN 215):	120 l/h
Specifications	
Closing dimension:	11.5 mm
Factory setting:	position 6
Identification	
- Blue protection cap with embossed 'PI' on the top	
- Blue plastic dial on the top of valve insert	

CONSTRUCTION

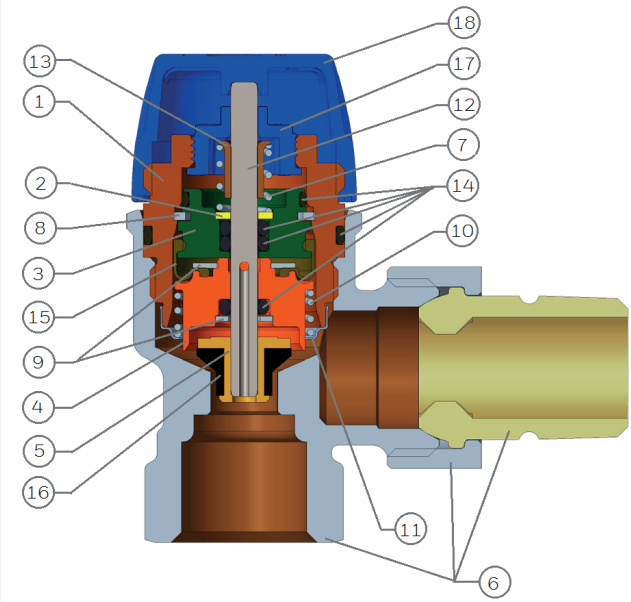
Overview	Components	Materials
	1 Insert body	Brass
	2 Washer	
	3 Holder	
	4 Pressure regulation bell	
	5 Plunger	
	6 Valve body, tailpiece, nut	
	7 Return spring	Stainless steel
	8 Retaining ring	
	9 Washer	
	10 Pressure regulation spring	
	11 Spring holder	
	12 Spindle	
	13 Spindle holder	Cu
	14 O-rings	EPDM
	15 Regulator membrane	
	16 Plunger seal	
	17 Setting dial	PBT
	18 Protection cap	PP

METHOD OF OPERATION

Kombi-TRV is controlled by the radiator thermostat.

Air from the room passing over the sensor of the radiator thermostat causes the sensor to expand when the temperature rises.

The sensor push the valve spindle and closing the valve.

When the temperature falls the sensor contracts and the spring-loaded valve spindle is opened.

The TRV opens in proportion to the temperature of the sensor. Only the amount of water required to maintain the room temperature set on the radiator thermostat can flow into the radiator.

Kombi-TRV has also an in-built flow limiter, allowing easy presetting of the maximum design flow through the radiator according to system requirements.

The defined flow can be set directly by turning the blue dial on the top of the valve to a particular number.

Kombi-TRV has also in-built pressure regulator, keeping the differential pressure at a constant level and therefore maintaining the set design flow constant.

As Kombi-TRV maintains the set flow rate stable independently from differential pressure, only the heating capacity and the resulting maximum flow rate have to be defined.

Consequently, complex calculations to determine the valve settings can be avoided.

TRANSPORTATION AND STORAGE

Keep parts in their original packaging and unpack them shortly before use.

The following parameters apply during transportation and storage:

Parameter	Value
Environment:	clean, dry and dust free
Min. ambient temperature:	0 °C
Max. ambient temperature:	40 °C
Max. ambient relative humidity:	75 % *

*non condensing

INSTALLATION GUIDELINES

Kombi-TRV suitable:

- Especially for thermostatic control of radiators with design flow up to 120 l/h
- In particular for two-pipe heating systems
- In particular for smaller and medium-size heating circuits
- In energy-efficient renovations of smaller systems where detailed calculation is not required
- For systems where the differential pressure across the Kombi-TRV will be between 10 kPa and 60 kPa

Two-pipe radiator systems

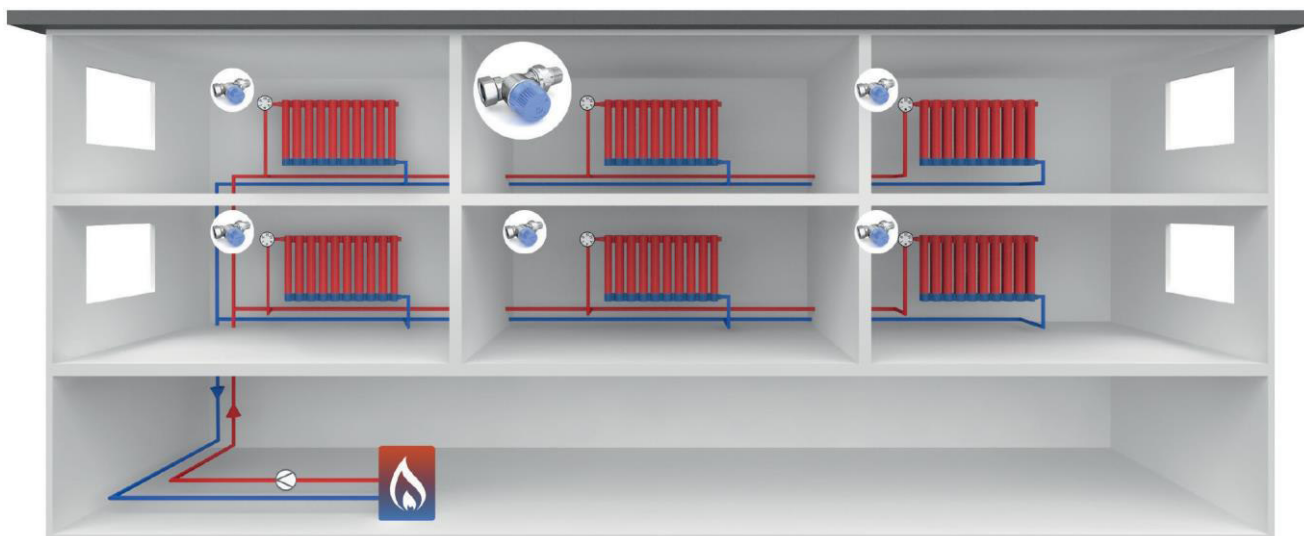

Kombi-TRV cannot be used in:

- Applications requiring flows exceeding 160 l/h
- Applications where differential pressure across the Kombi-TRV could exceed 60 kPa, for example in direct connection to central heating plant with high pump head or where water hammer could occur due to fast closing actuators. With fast closing actuators, the recommended max. differential pressure in the system is 45 kPa.
- Flow direction reverse to the arrow on the body

Setup requirements

- To avoid stone deposit and corrosion the composition of the medium should conform with VDI-Guideline 2035
- All additives and lubricants used for heating medium treatment have to be suitable for EPDM seals to avoid their disintegration. Use of mineral oils should be avoided
- For industrial and long-distance energy systems please refer to applicable codes VdTÜV and 1466/AGFW FW 510
- Heavy polluted existing heating systems must be flushed thoroughly before replacing thermostatic valves
- The heating system must be fully deaerated
- The blue protection cap must not be used as manual shut off device. A special manual handwheel cap should be used (see accessories)
- Any complaints or costs resulting from non-compliance with above rules will not be accepted by Honeywell Home

Recommended actuators

- Kombi-TRV flow characteristics are designed for control by thermostatic heads, which provide for proportional regulation within the 2K p-band stroke (0.45 mm). Kombi-TRV is therefore best controlled by a mechanical or electronic thermostatic head
- All Honeywell Home thermostatic radiator heads with M30x1.5 connection fit the Kombi-TRV
- Honeywell Home HR90, HR91 and HR92 electronic controllers are suitable for the Kombi-TRV
- Honeywell Home MT4 thermoelectric actuators, and M5410 2-point actuators can be used for on/off control of the Kombi-TRV
- Thermostatic radiator valves are intentionally designed such that the max. flow rate exceeds the nominal flow rate at 2K p-band stroke (0.45mm) by only about 40%. Thus, modulating actuators can effectively provide for proportional flow control only over a limited stroke range, because at higher strokes, the flow is limited by the presetting
- Honeywell Home M4410E/K and M7410E5001 modulating actuators are recommended for the Kombi-TRV

Installation Example

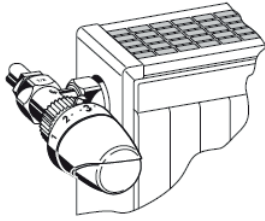

Angle

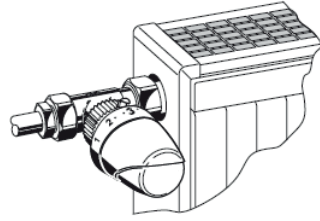

Straight

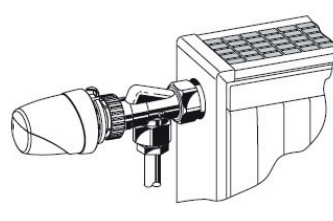

Horizontal angle

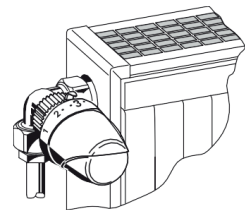

Double angle left

TECHNICAL CHARACTERISTICS

Flow chart and settings

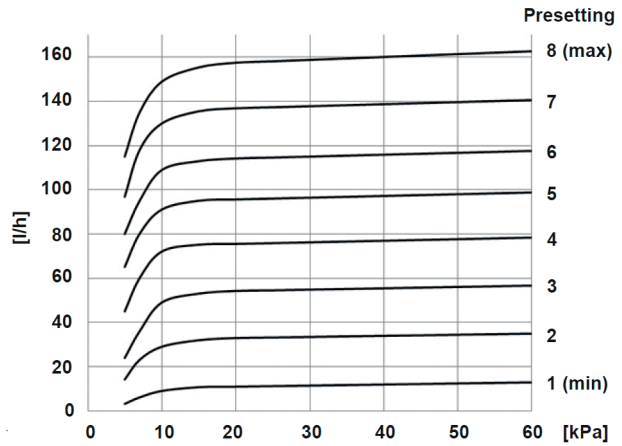
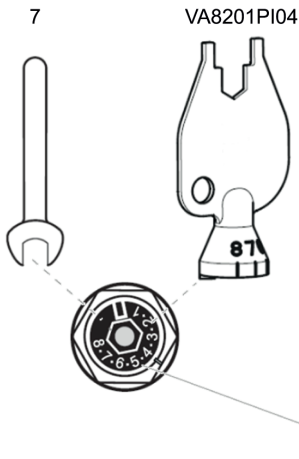

With standard heads (0.22 mm/K stroke)

n	1	*	2	*	3	*	4	*	5	*	6	*	7	*	8
Q (l/h), 1 K, 10 kPa	10	20	30	40	50	60	60	60	60	60	60	60	60	60	60
Q (l/h), 2 K, 10 kPa	10	20	30	40	50	65	75	85	95	105	110	112	115	117	120
Q _{max} (l/h)	10	20	30	40	50	65	75	85	95	105	115	125	140	150	160

With T6001HF head (0.35 mm/K stroke)

n	1	*	2	*	3	*	4	*	5	*	6	*	7	*	8
Q (l/h), 1 K, 10 kPa	10	20	30	40	50	65	75	75	75	75	75	75	75	75	75
Q (l/h), 2 K, 10 kPa	10	20	30	40	50	65	75	85	95	105	115	125	140	145	150

Presetting

- The flow rates can be steplessly adjusted between 1 to 8 (10 to 160 l/h)
- The default factory setting is position 6
- The setting is changed using either a special setting key (see accessories) or a standard 7 mm wrench
 - Slide the setting key on the hexagon of the blue plastic dial, ensuring that the 'embossed' part fits to the positioning slot (see Tab.)
 - Turn the setting key until the desired setting value reach the position of the index recess in the valve insert body
 - Remove the key or wrench
 - Do not try to set the valve to a setting higher than 8 or lower than 1. If you set to setting lower than 1, open the setting dial by turning to the left up to the end stop above setting 8, and then return back to the desired setting.

Design example

- Type 22 compact radiator 2200 x 500 mm
- Required heat: 1900 W
- Radiator ΔT : 15 °C
- Calculated design flow: 109 l/h
- Min. ΔP : 0,1 bar
- Valve setting: 6 (see also Tab.)

DIMENSIONS

Overview

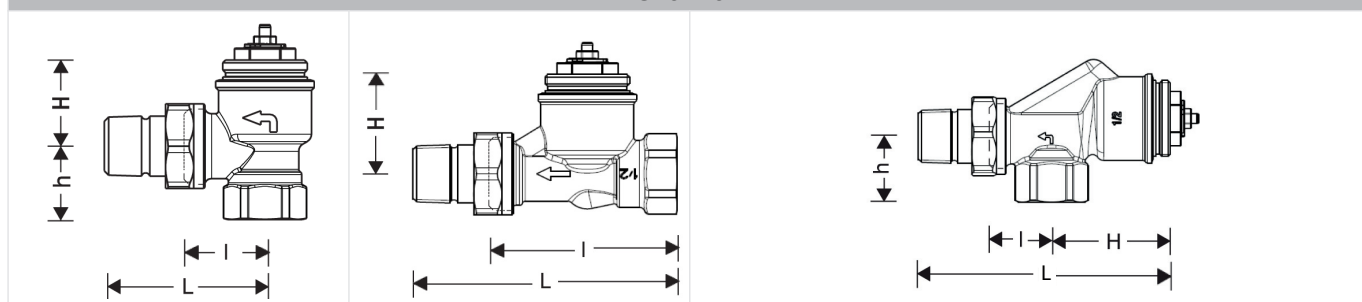
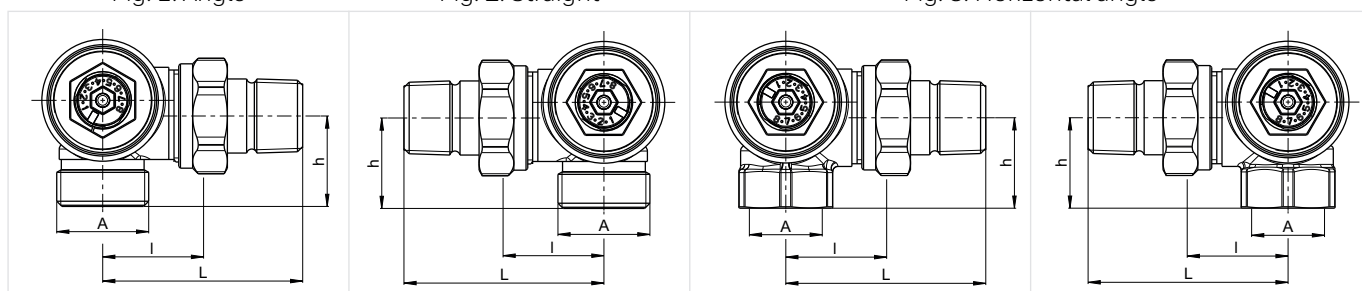

Fig. 1. Angle

Fig. 2. Straight

Fig. 3. Horizontal angle

Fig 4. Double angle left,
G 3/4"Fig 5. Double angle right,
G 3/4"Fig 6. Double angle left,
Rp 1/2"Fig 7. Double angle right,
Rp 1/2"

Body type	DN	EN 215 certified	Pipe connection A	Radiator connection	I	L	h	H	OS-No.
For the supply									
Angle to EN215 (D) (Fig. 1)	10	•	Rp 3/8"	R 3/8"	26	52	22	29	V2100EPI10
	15	•	Rp 1/2"	R 1/2"	29	58	26	31	V2100EPI15
	20	•	Rp 3/4"	R 3/4"	34	66	29	27	V2100EPI20
Straight to EN215 (D) (Fig. 2)	10	•	Rp 3/8"	R 3/8"	60	86	-	37	V2100DPI10
	15	•	Rp 1/2"	R 1/2"	66	95	-	37	V2100DPI15
	20	•	Rp 3/4"	R 3/4"	74	106	-	37	V2100DPI20
Horizontal angle (Fig. 3)	10		Rp 3/8"	R 3/8"	24	89	22	46	V2100API10
	15		Rp 1/2"	R 1/2"	26	96	26	48	V2100API15
Double angle left (Fig. 4 and Fig. 6)	10		Rp 1/2"	R 3/8"	29	58	26	38	V2100LPI10-1/2
	15		Rp 1/2"	R 1/2"	29	58	26	38	V2100LPI15
	15		G 3/4"	R 1/2"	29	58	26	38	V2106LPI15
Double angle right (Fig. 5 and Fig. 7)	10		Rp 1/2"	R 3/8"	29	58	26	38	V2100RPI10-1/2
	15		Rp 1/2"	R 1/2"	29	58	26	38	V2100RPI15
	15		G 3/4"	R 1/2"	29	58	26	38	V2106RPI15

Note: All dimensions in mm unless stated otherwise.



ORDERING INFORMATION

The following tables contain all the information you need to make an order of an item of your choice. When ordering, please always state the type, the ordering or the part number.

Options

Therafix-Kombi Type	Set contents	Pipe connection	Radiator connection	OS.-No.
Therafix-Kombi, left, white, for radiators with 1/2" internal thread, soft sealing, for G 3/4" Euroconus pipe fittings	V2106RPI15 V2427E0015 VA2174WLO15	G 3/4"	R 1/2"	VL2174WLY015
Therafix-Kombi, right, white, for radiators with 1/2" internal thread, soft sealing, for G 3/4" Euroconus pipe fittings	V2106LPI15 V2427E0015 VA2174WR015	G 3/4"	R 1/2"	VL2174WRY015

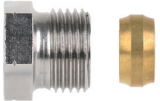
Accessories

	Description	Dimension	Part No.	
	FIG1/2CS Compression fitting for COPPER and STEEL pipe Consisting of compression nut and compression ring. For valves with internal thread. Note: Support inserts have to be used for copper or soft steel pipe with 1.0 mm wall thickness. Max. operating temperature 120 °C, max. operating pressure 10 bar.			
		3/8", DN10	10 mm	FIG3/8CS10
		3/8", DN10	12 mm	FIG3/8CS12
		1/2", DN15	10 mm	FIG1/2CS10
		1/2", DN15	12 mm	FIG1/2CS12
		1/2", DN15	14 mm	FIG1/2CS14
		1/2", DN15	15 mm	FIG1/2CS15
		1/2", DN15	16 mm	FIG1/2CS16
		3/4", DN20	18 mm	FIG3/4CS18
		3/4", DN20	22 mm	FIG3/4CS22
	FIG1/2CSS Compression fitting for COPPER and STEEL pipe Consisting of compression nut and compression ring and support insert. For valves with internal thread. Note: Support inserts have to be used for copper or soft steel pipe with 1.0 mm wall thickness. Max. operating temperature 120 °C, max. operating pressure 10 bar.			
		3/8", DN10	12 mm	FIG3/8CSS12
		1/2", DN15	12 mm	FIG1/2CSS12
		1/2", DN15	14 mm	FIG1/2CSS14
		1/2", DN15	15 mm	FIG1/2CSS15
		1/2", DN15	16 mm	FIG1/2CSS16
		1/2", DN15	18 mm	FIG1/2CSS18
		3/4", DN20	18 mm	FIG3/4CSS18
	FIG1/2M Compression fitting for MULTILAYER pipe. Consisting of compression nut, compression ring and support insert. For valves with internal thread. Note: Max. operating temperature 90°C, max. operating pressure 10 bar			
		1/2", DN15	16 mm	FIG1/2M16X2
	FEG3/4CS Compressions fitting for copper and precision steel pipes One-piece fitting with steel reinforced elastic ring			
		3/4"	10 mm	FEG3/4CS10
		3/4"	12 mm	FEG3/4CS12
		3/4"	14 mm	FEG3/4CS14
		3/4"	15 mm	FEG3/4CS15
		3/4"	16 mm	FEG3/4CS16
		3/4"	18 mm	FEG3/4CS18
	FEG3/4PM Compression fitting for PEX and MULTILAYER pipe. Consisting of a nut with pre-assembled anti-torsion compression ring and a reinforcing insert.			
		3/4"	14 x 2 mm	FEG3/4PM14X2
		3/4"	16 x 2 mm	FEG3/4PM16X2
		3/4"	16 x 2.2 mm	FEG3/4PM16X2.2
		3/4"	17 x 2 mm	FEG3/4PM17X2
		3/4"	18 x 2 mm	FEG3/4PM18X2
		3/4"	20 x 2 mm	FEG3/4PM20X2

	FEG3/4P	Compression fitting for PEX/PER pipe Consisting of 2 union nuts, 2 compression rings and 2 support inserts		
		$\frac{3}{4}$ "	12 x 1.1 mm	FEG3/4P12X1.1
		$\frac{3}{4}$ "	16 x 1.5 mm	FEG3/4P16X1.5
	VA6290	Reduction		
		1" pipe > $\frac{1}{2}$ " valve		VA6290A260
		1 $\frac{1}{4}$ " pipe > $\frac{1}{2}$ " valve		VA6290A280
		1" pipe > $\frac{3}{4}$ " valve		VA6290A285
		1 $\frac{1}{4}$ " pipe > $\frac{3}{4}$ " valve		VA6290A305
	VA5201Axxx	Radiator tailpiece with thread up to collar		
		for valves DN10 ($\frac{3}{8}$ "		VA5201A010
		for valves DN15 ($\frac{1}{2}$ "		VA5201A015
		for valves DN20 ($\frac{3}{4}$ "		VA5201A020
	VA5204Bxxx	Extended radiator tailpiece, nickel-plated, to be shortened as required		
		$\frac{3}{8}$ " x 70 mm (for DN10) thread approx. 50 mm		VA5204B010
		$\frac{1}{2}$ " x 76 mm (for DN15) thread approx. 65 mm		VA5204B015
		$\frac{3}{4}$ " x 70 mm (for DN20) thread approx. 60 mm		VA5204B020
	H100	Manual handwheel		
		Pack of 10 pcs		H100-1/2A
	VA2202Axxx	Pressure cap – for shutting off valves on radiator outlet		
		for valves DN10 ($\frac{3}{8}$ "		VA2202A010
		for valves DN15 ($\frac{1}{2}$ "		VA2202A015
		for valves DN20 ($\frac{3}{4}$ "		VA2202A020
	VA5090	Sealing ring for pressure cap		
		for valves DN10 ($\frac{3}{8}$ "		VA5090A010
		for valves DN15 ($\frac{1}{2}$ "		VA5090A015
		for valves DN20 ($\frac{3}{4}$ "		VA5090A020
	VA8200A	Service tool to replace valve insert		
		for all PI types		VA8200A003
	VA8201	Presetting key		
		for all PI, VS, FS, FV and SL type valves		VA8201PI04

	VS1200	Replacement valve insert	
		PI type	VS1200PI01
	VA2174W	Spare decorative covers for Therafix-Kombi, white RAL 9016	
		for VL2174WLY015 Therafix-Kombi left	VA2174WL015
		for VL2174WRY015 Therafix-Kombi right	VA2174WR015

For more information

homecomfort.resideo.com/europe



Ademco 1 GmbH
 Hardhofweg 40
 74821 MOSBACH
 GERMANY
 Phone: +49 6261 810
 Fax: +49 6261 81309

Manufactured for and on behalf of the
 Pittway Sàrl, La Pièce 4, 1180 Rolle, Switzerland
 by its Authorised Representative Ademco 1 GmbH
 EN0H-2040GE23 R0520

Subject to change

© 2020 Pittway Sàrl. All rights reserved.

This document contains proprietary information of
 Pittway Sàrl and its affiliated companies and is
 protected by copyright and other international laws.
 Reproduction or improper use without specific
 written authorisation of Pittway Sàrl is strictly
 forbidden. The Honeywell Home trademark is used
 under license from Honeywell International Inc.

Honeywell Home